

7510Z1 7030T1 7510T1 Set

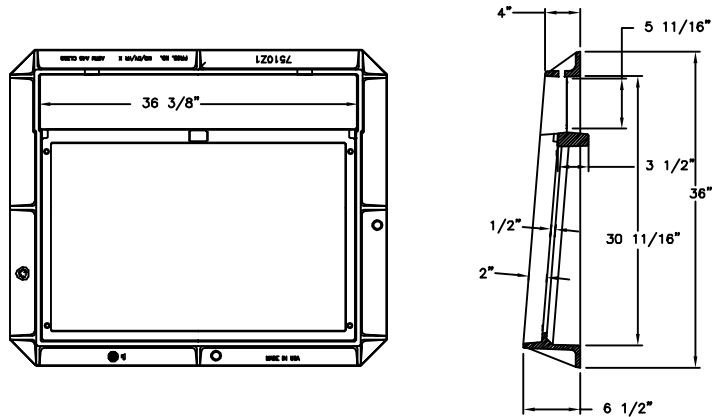

FRAME SECTION

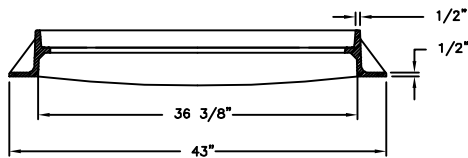

FRAME SECTION

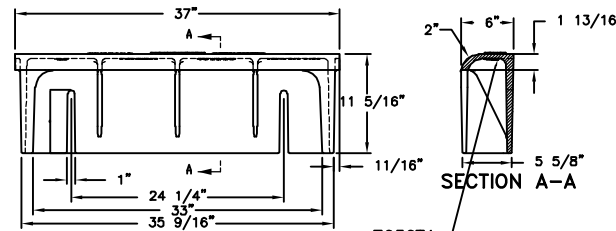
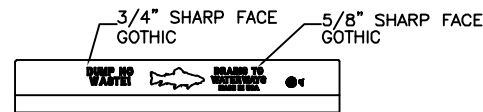

SECTION A-A

7030T1
MADE IN USA
ASTM A48 CL35B
PROD. NO.
MO/DY/YR X
RECYCLE SYMBOL

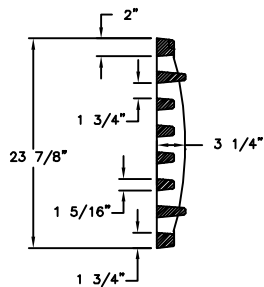
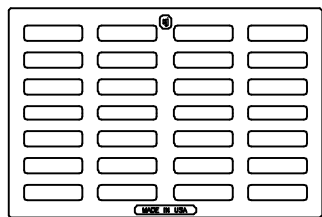

GRATE SECTION

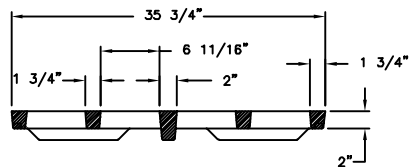

GRATE SECTION

Product Number
00751037C20

Design Features

- Materials
 - Curb Inlet Frame
Gray Iron (CL35B)
 - Hood
Gray Iron (CL35B)
 - Grate
Gray Iron (CL35B)

- Design Load
Heavy Duty
- Open Area
324 Sq. Inches
- Coating
Undipped
- √ Designates Machined Surface

Certification

-
-
-
- Country of Origin: USA

Major Components

00751013
00703069
00751037

Drawing Revision

4/9/2020 Designer: MAH
Revised By:

Disclaimer

Weights (lbs./kg) dimensions (inches/mm) and drawings provided for your guidance. We reserve the right to modify specifications without prior notice.

CONFIDENTIAL: This drawing is the property of EJ GROUP, Inc., and embodies confidential information, registered marks, patents, trade secret information, and/or know how that is the property of EJ GROUP, Inc. Copyright © 2012 EJ GROUP, Inc. All rights reserved.

Contact

800 626 4653
ejco.com

CURB ADJUSTMENT
3 1/4" TO 9"

Supplied By:
TRENCHDRAIN SUPPLY
877-903-7246
www.trenchdrainsupply.com